

4. Spatial kinematics. Constraint.

Mechanics of Manipulation

Matt Mason

`matt.mason@cs.cmu.edu`

`http://www.cs.cmu.edu/~mason`

Carnegie Mellon

Chapter 1 Manipulation 1

- 1.1 Case 1: Manipulation by a human 1
- 1.2 Case 2: An automated assembly system 3
- 1.3 Issues in manipulation 5
- 1.4 A taxonomy of manipulation techniques 7
- 1.5 Bibliographic notes 8
- Exercises 8

Chapter 2 Kinematics 11

- 2.1 Preliminaries 11
- 2.2 Planar kinematics 15
- 2.3 Spherical kinematics 20
- 2.4 Spatial kinematics 22
- 2.5 Kinematic constraint 25
- 2.6 Kinematic mechanisms 34
- 2.7 Bibliographic notes 36
- Exercises 37

Chapter 3 Kinematic Representation 41

- 3.1 Representation of spatial rotations 41
- 3.2 Representation of spatial displacements 58
- 3.3 Kinematic constraints 68
- 3.4 Bibliographic notes 72
- Exercises 72

Chapter 4 Kinematic Manipulation 77

- 4.1 Path planning 77
- 4.2 Path planning for nonholonomic systems 84
- 4.3 Kinematic models of contact 86
- 4.4 Bibliographic notes 88
- Exercises 88

Chapter 5 Rigid Body Statics 93

- 5.1 Forces acting on rigid bodies 93
- 5.2 Polyhedral convex cones 99
- 5.3 Contact wrenches and wrench cones 102
- 5.4 Cones in velocity twist space 104
- 5.5 The oriented plane 105
- 5.6 Instantaneous centers and Reuleaux's method 109
- 5.7 Line of force; moment labeling 110
- 5.8 Force dual 112
- 5.9 Summary 117
- 5.10 Bibliographic notes 117
- Exercises 118

Chapter 6 Friction 121

- 6.1 Coulomb's Law 121
- 6.2 Single degree-of-freedom problems 123
- 6.3 Planar single contact problems 126
- 6.4 Graphical representation of friction cones 127
- 6.5 Static equilibrium problems 128
- 6.6 Planar sliding 130
- 6.7 Bibliographic notes 139
- Exercises 139

Chapter 7 Quasistatic Manipulation 143

- 7.1 Grasping and fixturing 143
- 7.2 Pushing 147
- 7.3 Stable pushing 153
- 7.4 Parts orienting 162
- 7.5 Assembly 168
- 7.6 Bibliographic notes 173
- Exercises 175

Chapter 8 Dynamics 181

- 8.1 Newton's laws 181
- 8.2 A particle in three dimensions 181
- 8.3 Moment of force; moment of momentum 183
- 8.4 Dynamics of a system of particles 184
- 8.5 Rigid body dynamics 186
- 8.6 The angular inertia matrix 189
- 8.7 Motion of a freely rotating body 195
- 8.8 Planar single contact problems 197
- 8.9 Graphical methods for the plane 203
- 8.10 Planar multiple-contact problems 205
- 8.11 Bibliographic notes 207
- Exercises 208

Chapter 9 Impact 211

- 9.1 A particle 211
- 9.2 Rigid body impact 217
- 9.3 Bibliographic notes 223
- Exercises 223

Chapter 10 Dynamic Manipulation 225

- 10.1 Quasidynamic manipulation 225
- 10.2 Brie y dynamic manipulation 229
- 10.3 Continuously dynamic manipulation 230
- 10.4 Bibliographic notes 232
- Exercises 235

Appendix A Infinity 237

Outline.

- Spherical kinematics
 - Euler's theorem
 - Cones
- Spatial kinematics
 - Chasles' theorem
 - Screws and twists
 - Axodes
- Kinematic constraint
 - Overview
 - Taxonomy and terminology
 - Reuleaux' method for unilateral constraints

About spherical kinematics

- Why study motions of the sphere? Because it corresponds to rotations about a given point of \mathbb{E}^3 .

About spherical kinematics

- Why study motions of the sphere? Because it corresponds to rotations about a given point of \mathbb{E}^3 .
- There is a close connection to planar kinematics. Let the radius of the sphere approach infinity ...

Two not-antipodal points enough

Theorem 2.5: A displacement of the sphere is completely determined by the motion of any two points that are not antipodal.

Proof: Construct a coordinate frame . . .

Euler's theorem

Theorem 2.6: For every spatial rotation, there is a line of fixed points. In other words, every rotation about a point is a rotation about a line, called the *rotation axis*.

Proof:

Prove that every displacement of the sphere has a fixed point.

Define $A, \perp AA', B, B', \perp BB'$.

Define C to be either intersection of $\perp AA'$ with $\perp BB'$.

Let R be the rotation mapping A to A' and C to itself.

Show R maps B to B' , so R is the given displacement.

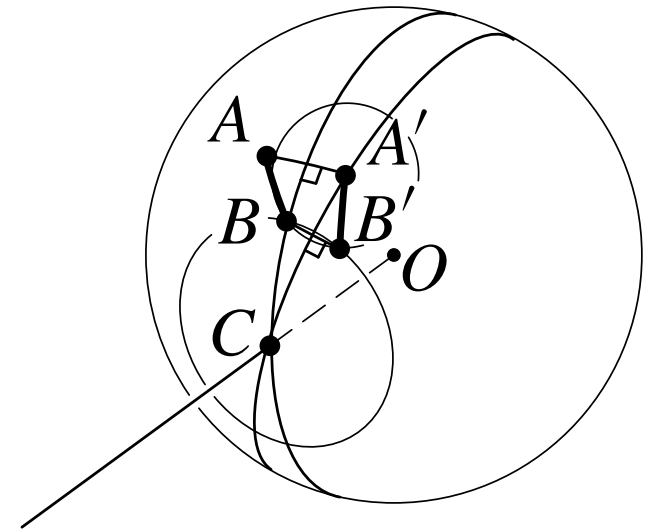

Review of displacements: planar and spherical

For the Euclidean plane, are there ...
... rotations that are not translations?

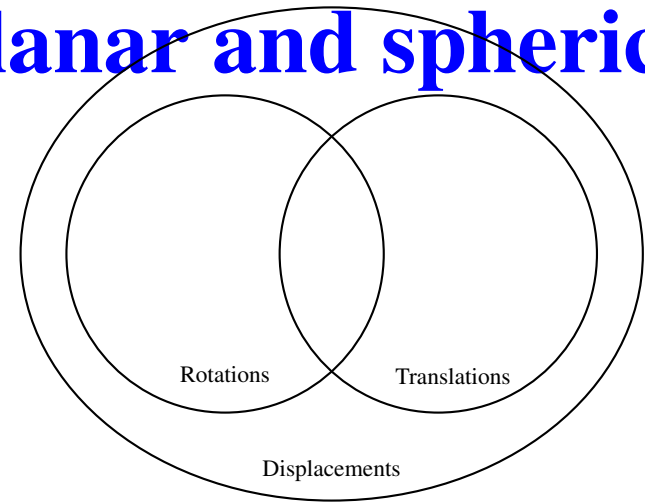

The Euclidean plane

For the sphere, are there ...

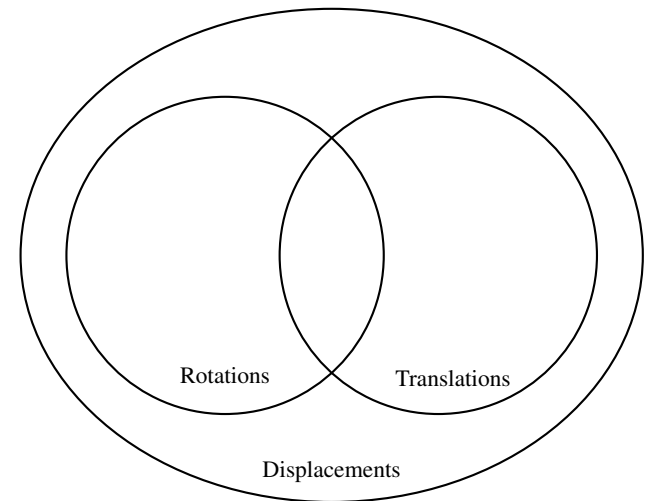

Review of displacements: planar and spherical

For the Euclidean plane, are there ...

... rotations that are not translations?

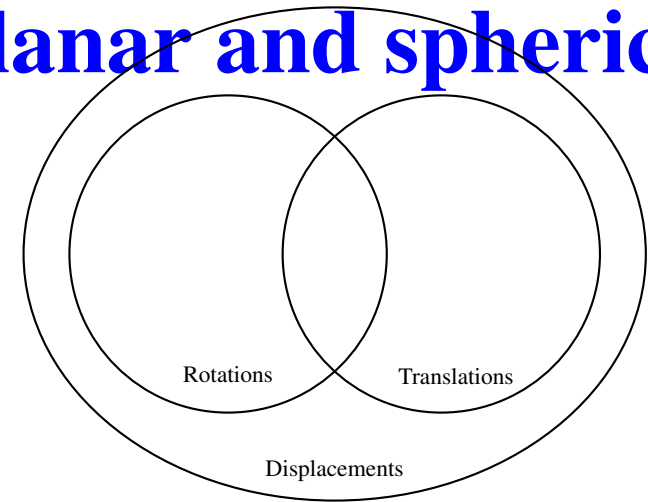

Lots!

The Euclidean plane

For the sphere, are there ...

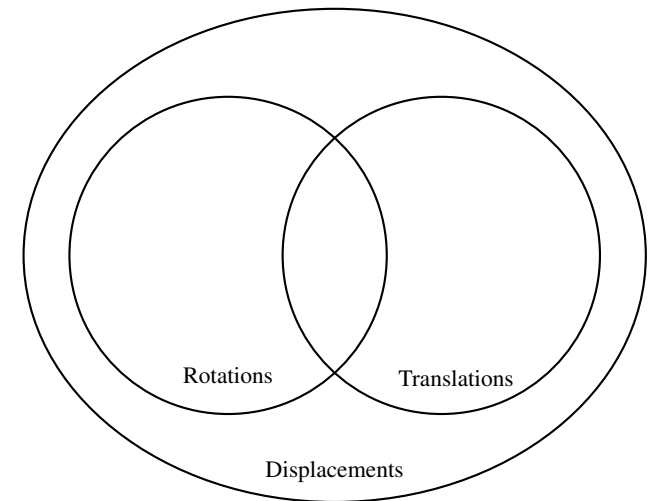

Review of displacements: planar and spherical

For the Euclidean plane, are there ...

... rotations that are not translations?

... translations that are not rotations?

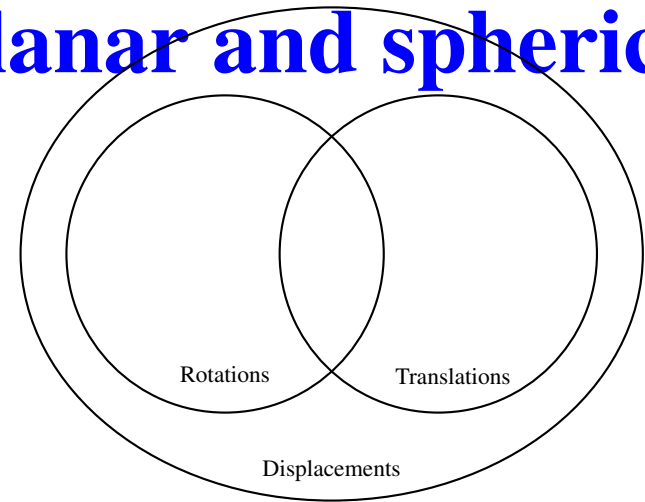

Lots!

The Euclidean plane

For the sphere, are there ...

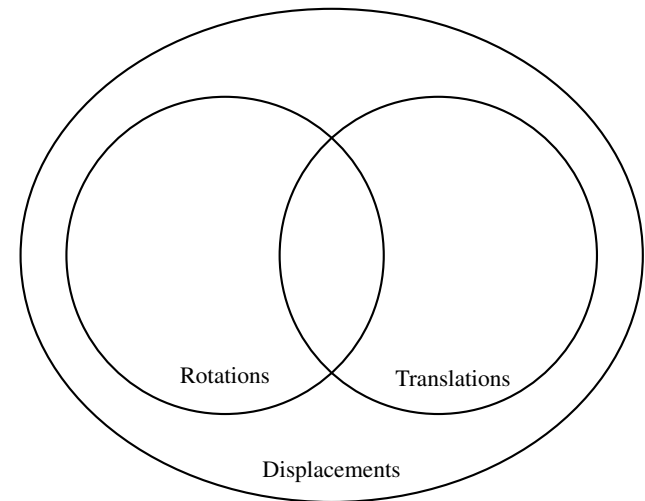

Review of displacements: planar and spherical

For the Euclidean plane, are there ...

... rotations that are not translations?

... translations that are not rotations?

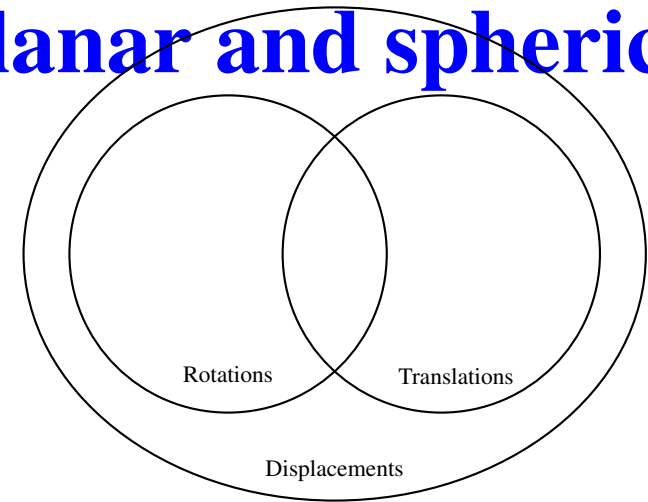

Sotse.

The Euclidean plane

For the sphere, are there ...

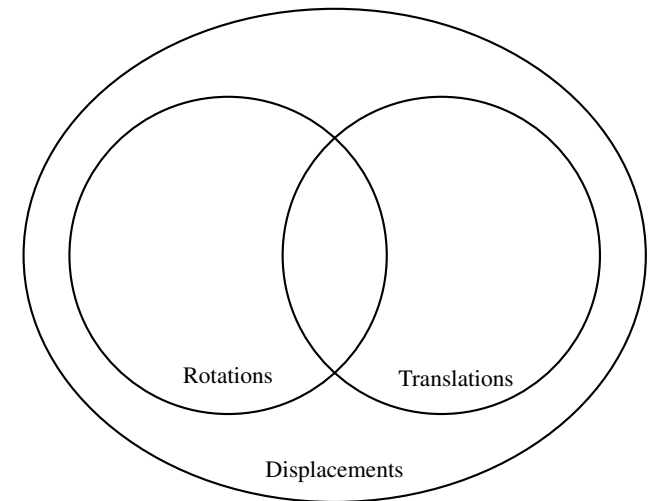

Review of displacements: planar and spherical

For the Euclidean plane, are there ...

... rotations that are not translations?

... translations that are not rotations?

... displacements that are both rotations and translations?

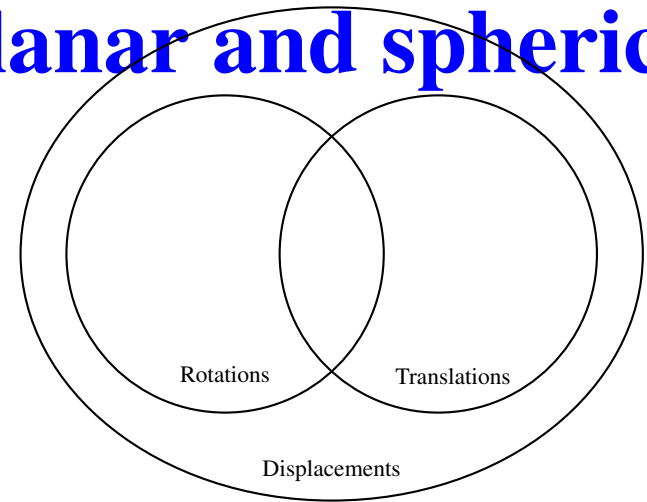

Sotse.

The Euclidean plane

For the sphere, are there ...

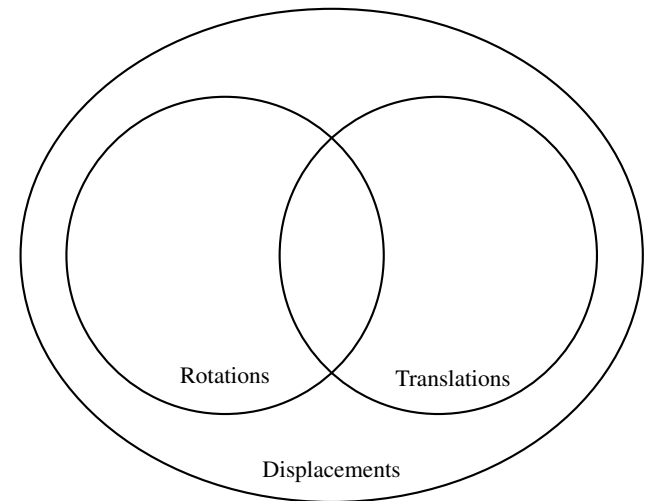

Review of displacements: planar and spherical

For the Euclidean plane, are there ...

... rotations that are not translations?

... translations that are not rotations?

... displacements that are both rotations and translations?

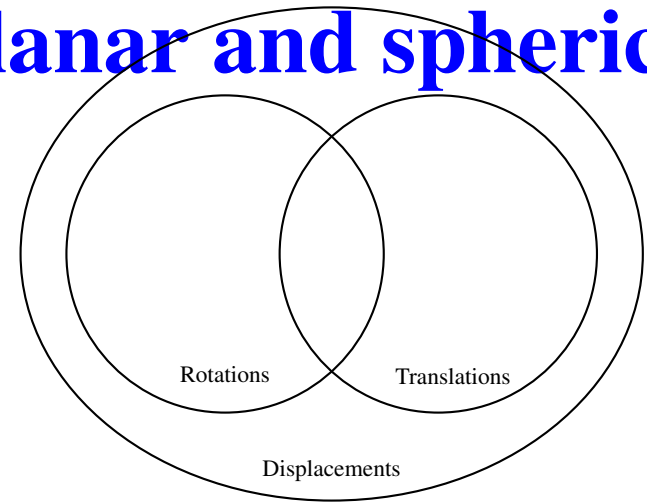

Solse.

The Euclidean plane

For the sphere, are there ...

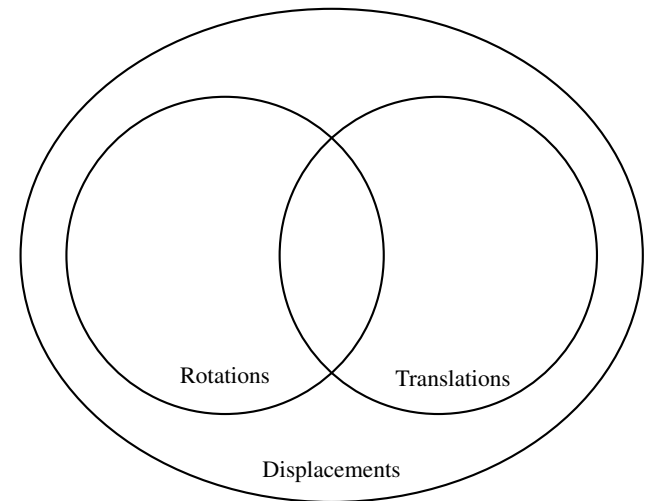

Review of displacements: planar and spherical

For the Euclidean plane, are there ...

... rotations that are not translations?

... translations that are not rotations?

... displacements that are both rotations and translations?

... displacements that are neither?

For the sphere, are there ...

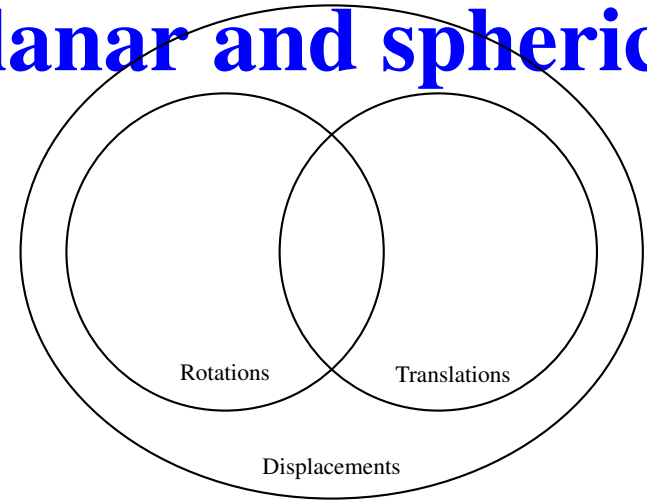

Solse.

The Euclidean plane

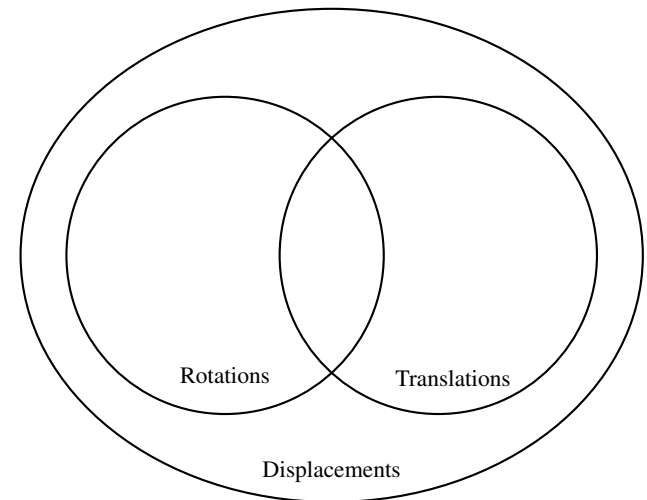

Review of displacements: planar and spherical

For the Euclidean plane, are there ...

... rotations that are not translations?

... translations that are not rotations?

... displacements that are both rotations and translations?

... displacements that are neither?

For the sphere, are there ...

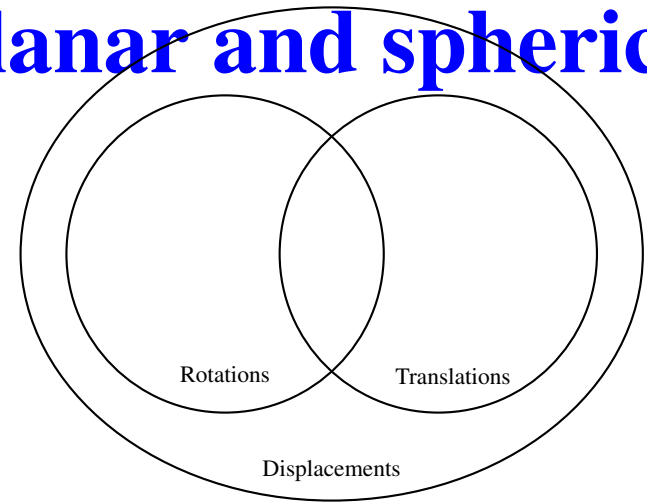

~~None.~~
Some.

The Euclidean plane

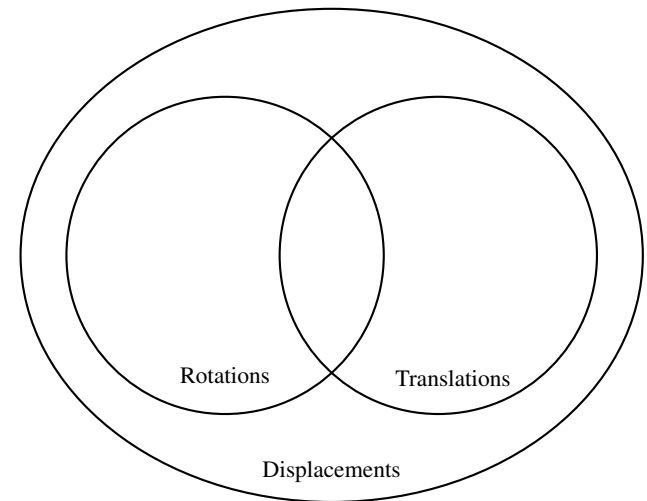

Review of displacements: planar and spherical

For the Euclidean plane, are there ...

... rotations that are not translations?

... translations that are not rotations?

... displacements that are both rotations and translations?

... displacements that are neither?

For the sphere, are there ...

... rotations that are not translations?

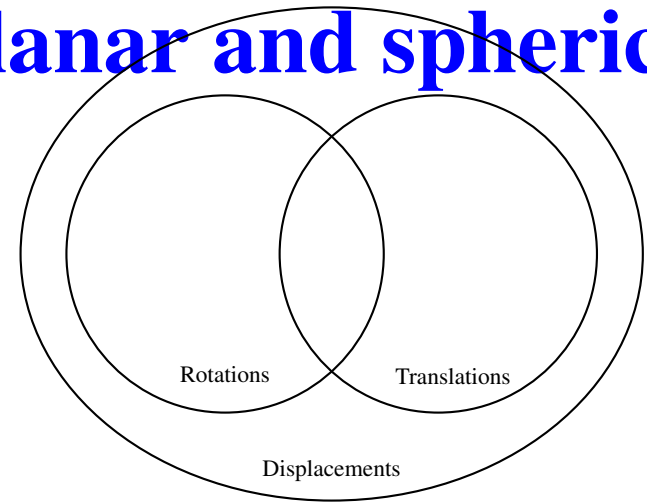

~~None.~~
Some.

The Euclidean plane

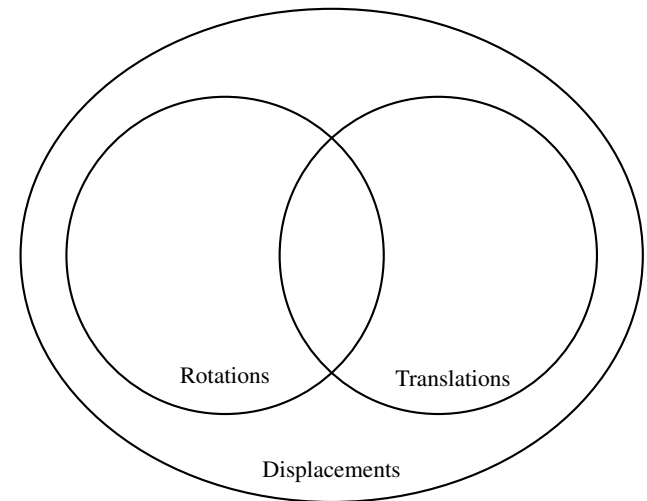

Review of displacements: planar and spherical

For the Euclidean plane, are there ...

... rotations that are not translations?

... translations that are not rotations?

... displacements that are both rotations and translations?

... displacements that are neither?

For the sphere, are there ...

... rotations that are not translations?

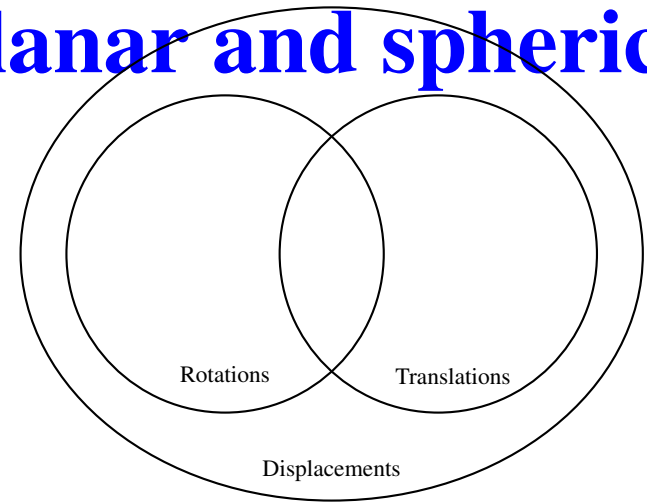

~~None.~~
Some.

The Euclidean plane

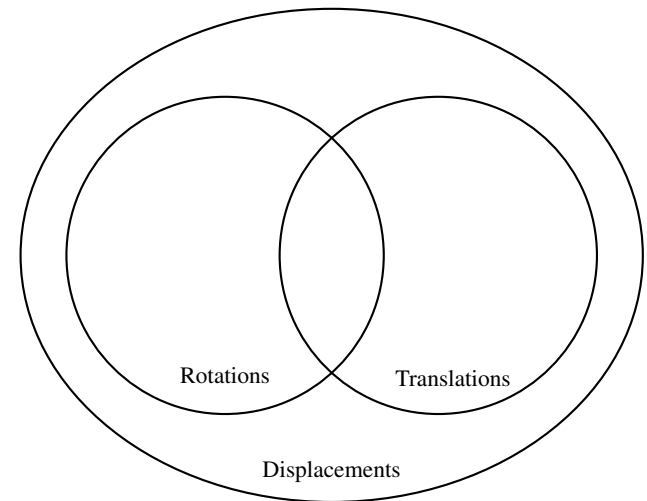

Lots!

Review of displacements: planar and spherical

For the Euclidean plane, are there ...

... rotations that are not translations?

... translations that are not rotations?

... displacements that are both rotations and translations?

... displacements that are neither?

For the sphere, are there ...

... rotations that are not translations?

... translations that are not rotations?

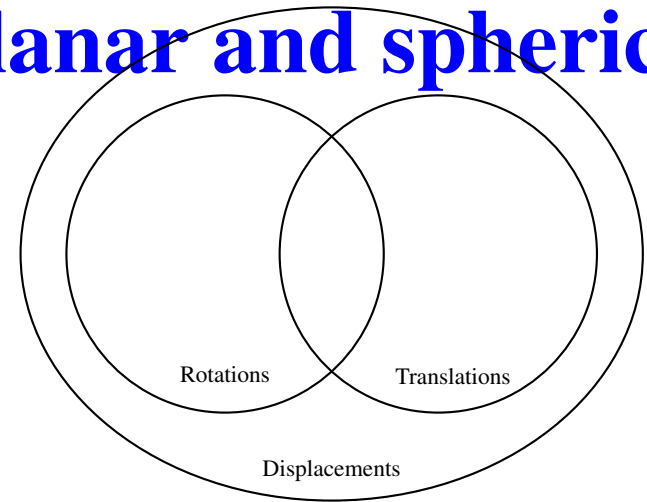

~~None.~~

The Euclidean plane

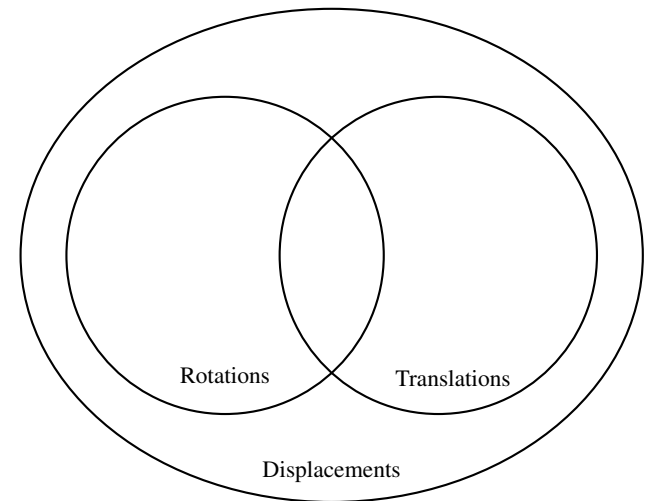

Lots!

The sphere

Review of displacements: planar and spherical

For the Euclidean plane, are there ...

... rotations that are not translations?

... translations that are not rotations?

... displacements that are both rotations and translations?

... displacements that are neither?

For the sphere, are there ...

... rotations that are not translations?

... translations that are not rotations?

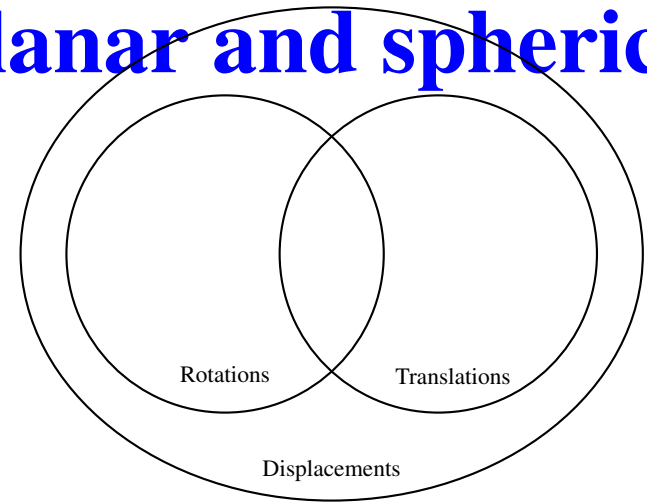

~~None.~~

The Euclidean plane

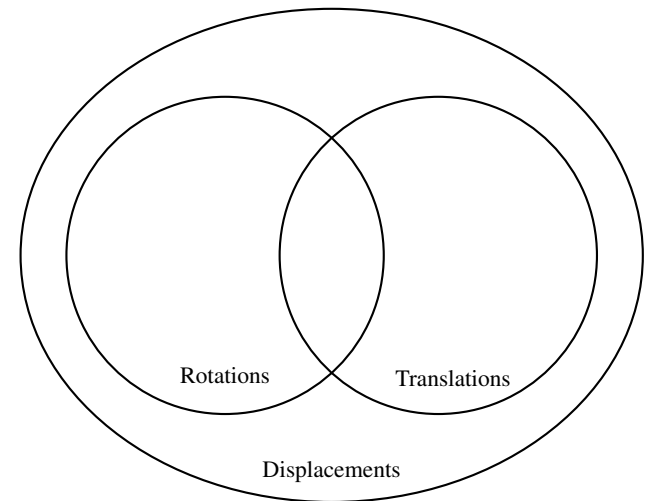

~~None.~~

The sphere

Review of displacements: planar and spherical

For the Euclidean plane, are there ...

- ... rotations that are not translations?
- ... translations that are not rotations?
- ... displacements that are both rotations and translations?
- ... displacements that are neither?

For the sphere, are there ...

- ... rotations that are not translations?
- ... translations that are not rotations?
- ... displacements that are both

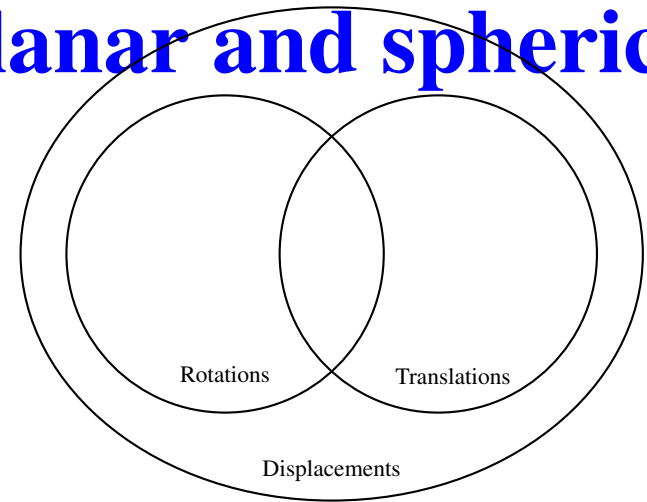

~~None.~~

The Euclidean plane

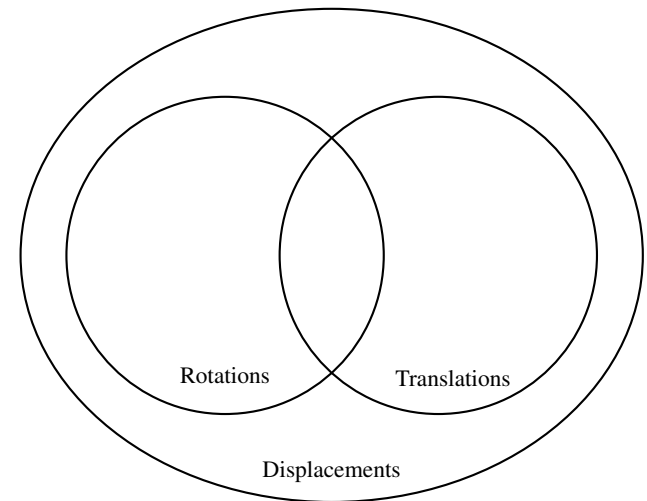

~~None.~~

The sphere

Review of displacements: planar and spherical

For the Euclidean plane, are there ...

- ... rotations that are not translations?
- ... translations that are not rotations?
- ... displacements that are both rotations and translations?
- ... displacements that are neither?

For the sphere, are there ...

- ... rotations that are not translations?
- ... translations that are not rotations?
- ... displacements that are both

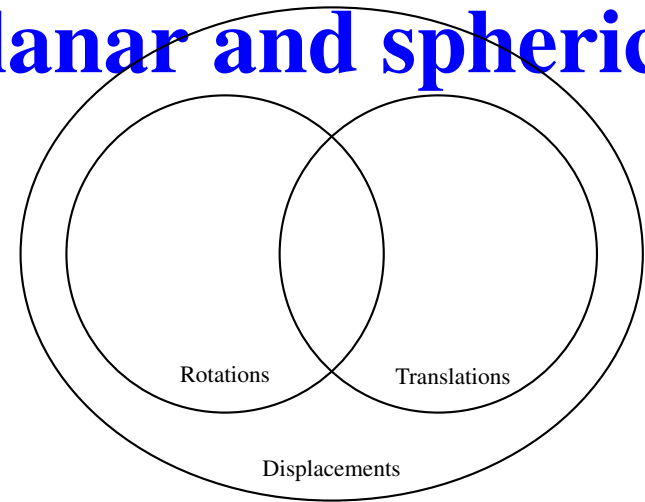

~~None.~~
Some.

The Euclidean plane

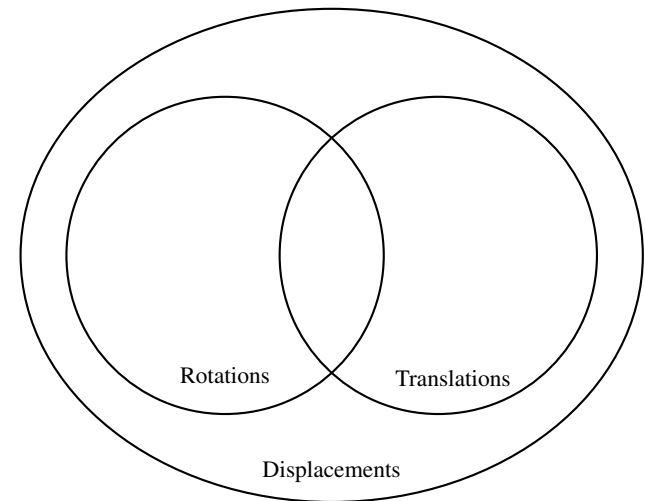

~~None.~~
None.

Review of displacements: planar and spherical

For the Euclidean plane, are there ...

- ... rotations that are not translations?
- ... translations that are not rotations?
- ... displacements that are both rotations and translations?
- ... displacements that are neither?

For the sphere, are there ...

- ... rotations that are not translations?
- ... translations that are not rotations?
- ... displacements that are both

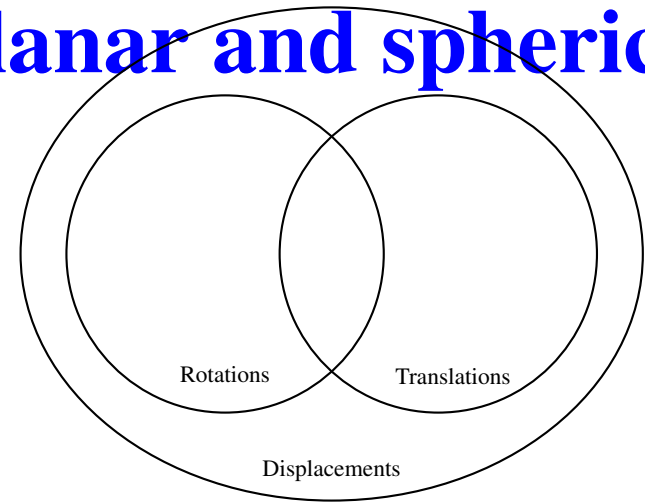

~~None.~~
Some.

The Euclidean plane

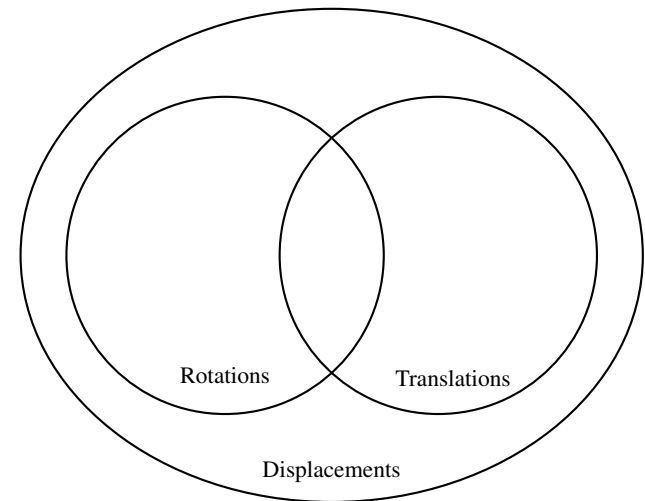

~~None.~~
None.

Review of displacements: planar and spherical

For the Euclidean plane, are there ...

- ... rotations that are not translations?
- ... translations that are not rotations?
- ... displacements that are both rotations and translations?
- ... displacements that are neither?

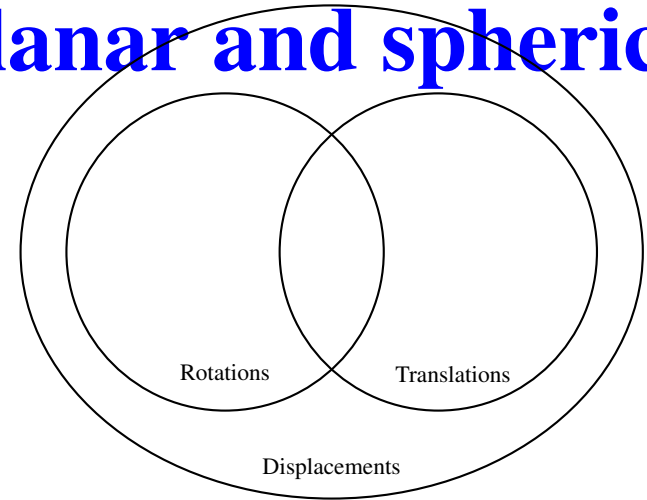

~~None.~~
Some.

The Euclidean plane

For the sphere, are there ...

- ... rotations that are not translations?
- ... translations that are not rotations?
- ... displacements that are both

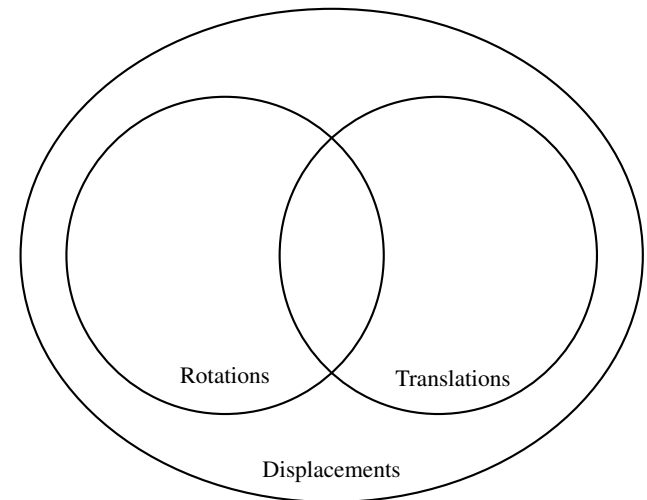

~~None.~~
None

The sphere

Preview of spatial displacements

For the Euclidean plane, are there ...

... rotations that are not translations?

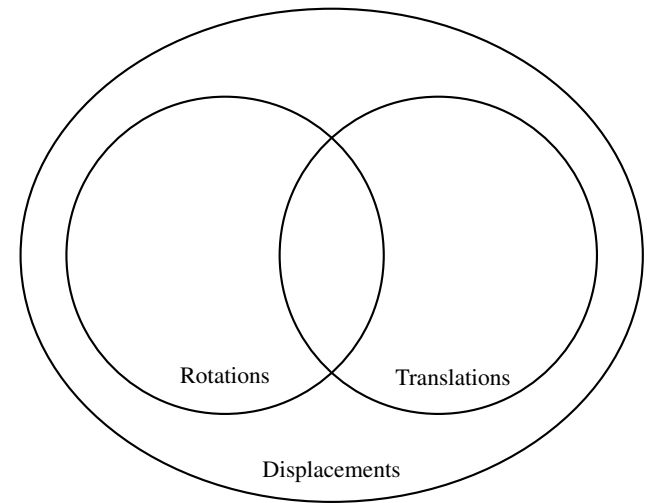

Euclidean three space

Preview of spatial displacements

For the Euclidean plane, are there ...

... rotations that are not translations?

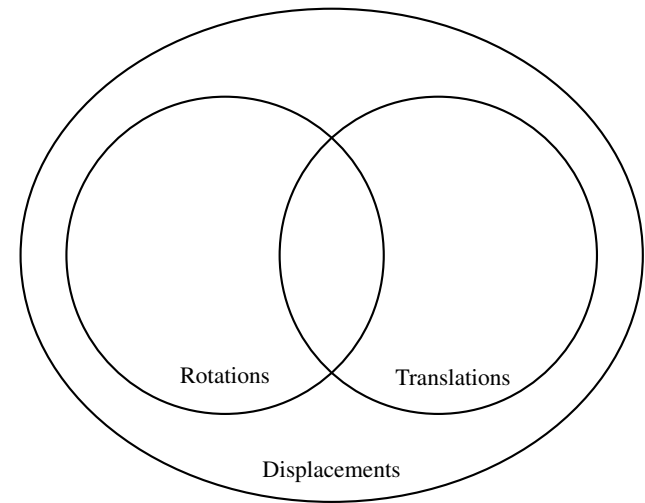

Lots!

Euclidean three space

Preview of spatial displacements

For the Euclidean plane, are there ...

... rotations that are not translations?

... translations that are not rotations?

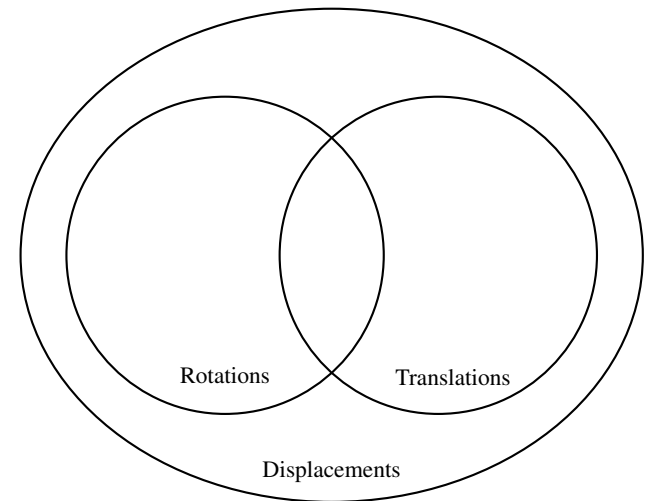

Lots!

Euclidean three space

Preview of spatial displacements

For the Euclidean plane, are there ...

... rotations that are not translations?

... translations that are not rotations?

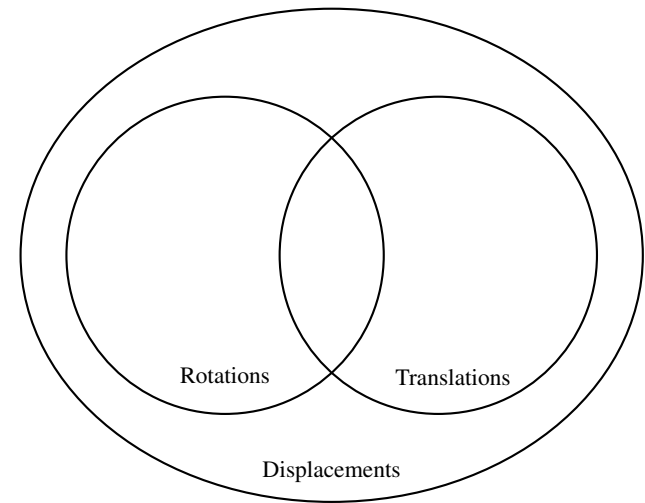

~~Lots!~~

Euclidean three space

Preview of spatial displacements

For the Euclidean plane, are there ...

... rotations that are not translations?

... translations that are not rotations?

... displacements that are both rotations and translations?

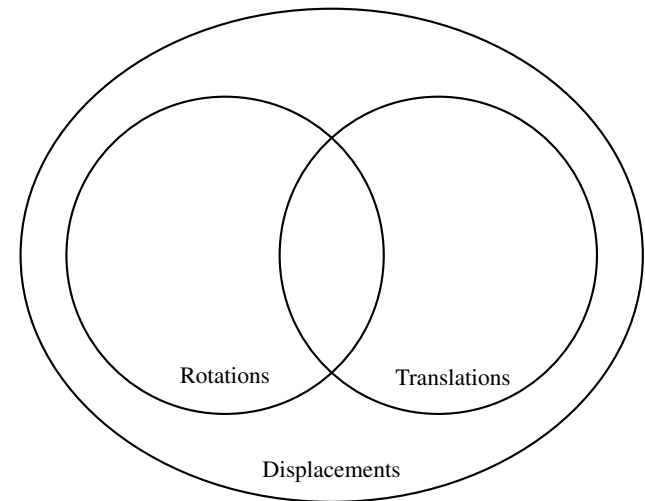

~~Lots!~~

Euclidean three space

Preview of spatial displacements

For the Euclidean plane, are there ...

... rotations that are not translations?

... translations that are not rotations?

... displacements that are both rotations and translations?

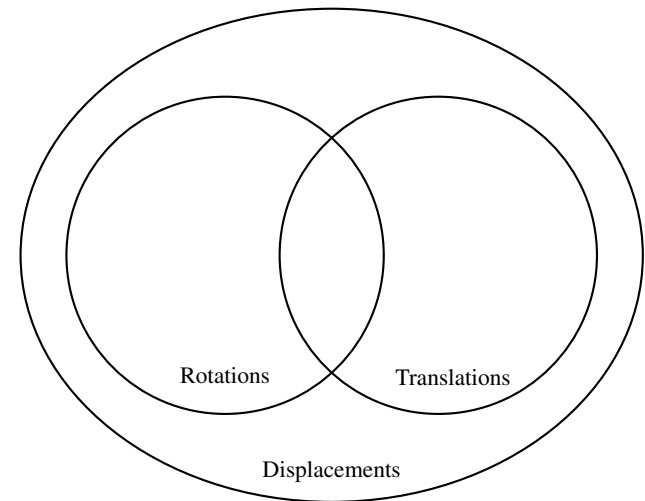

~~Lots!~~

Euclidean three space

Preview of spatial displacements

For the Euclidean plane, are there ...

... rotations that are not translations?

... translations that are not rotations?

... displacements that are both rotations and translations?

... displacements that are neither?

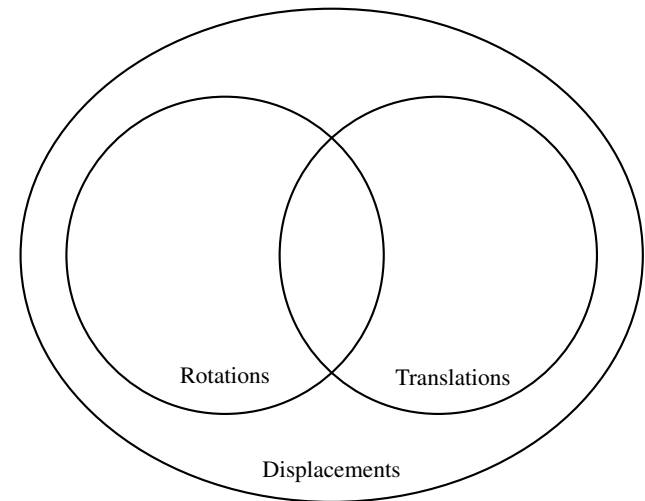

Lots!

Euclidean three space

Preview of spatial displacements

For the Euclidean plane, are there ...

... rotations that are not translations?

... translations that are not rotations?

... displacements that are both rotations and translations?

... displacements that are neither?

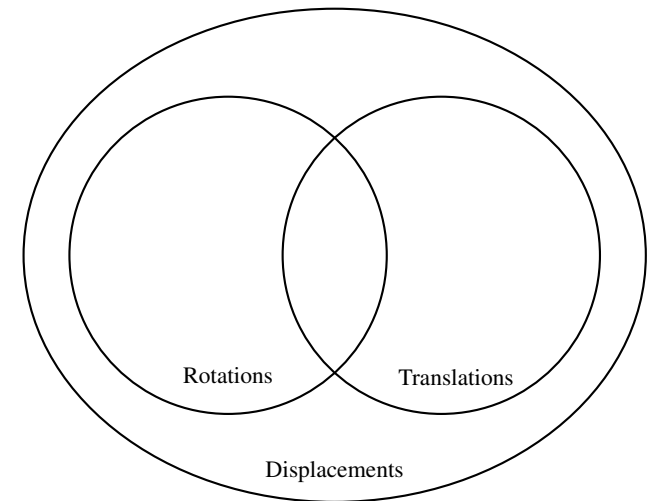

~~Screws!~~

Euclidean three space

Preview of spatial displacements

For the Euclidean plane, are there ...

... rotations that are not translations?

... translations that are not rotations?

... displacements that are both rotations and translations?

... displacements that are neither?

... displacements that are not screws?

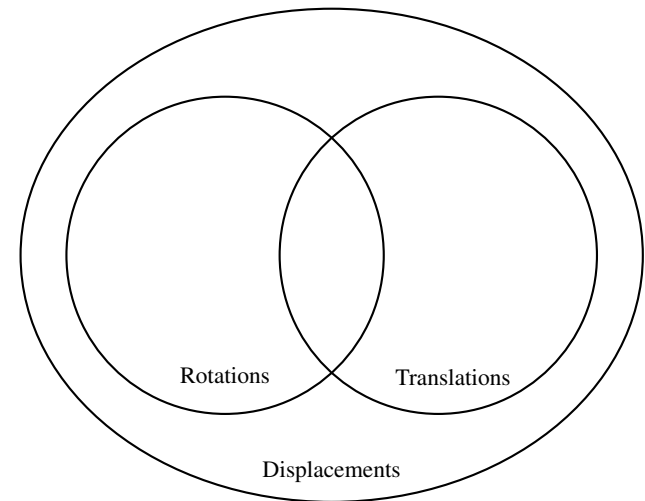

~~Screws!~~

Euclidean three space

Preview of spatial displacements

For the Euclidean plane, are there ...

... rotations that are not translations?

... translations that are not rotations?

... displacements that are both rotations and translations?

... displacements that are neither?

... displacements that are not screws?

No. Chasles' theorem

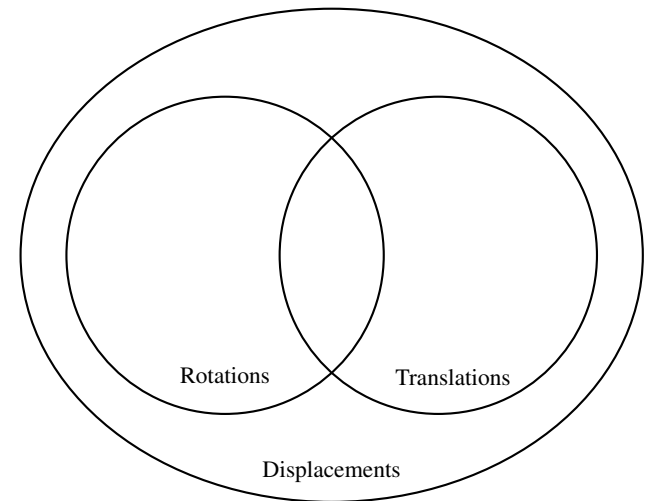

Screws!

Euclidean three space

Chasles's theorem

Theorem 2.7: Every spatial displacement is the composition of a rotation about some axis, and a translation along the same axis.

Proof:

Assume arbitrary displacement D is given.

Use theorem 2.2 to decompose $D = R \circ T$.

Decompose T into components parallel to and perpendicular to axis of R : $D = R \circ T_{\perp} \circ T_{\parallel}$.

Note that $R \circ T_{\perp}$ is planar! Every plane perpendicular to rotation axis is mapped rigidly to itself.

If $R \circ T_{\perp}$ is a translation the theorem follows immediately.

Otherwise $R \circ T_{\perp}$ is a rotation about some axis parallel to the rotation axis of R .

So $D = (R \circ T_{\perp}) \circ T_{\parallel}$ is the desired decomposition.

Screws.

A *screw* is a line in space with an associated pitch, which is a ratio of linear to angular quantities.

A *twist* is a screw plus a scalar magnitude, giving a rotation about the screw axis plus a translation along the screw axis. The rotation angle is the twist magnitude, and the translation distance is the magnitude times the pitch. Thus the pitch is the ratio of translation to rotation.

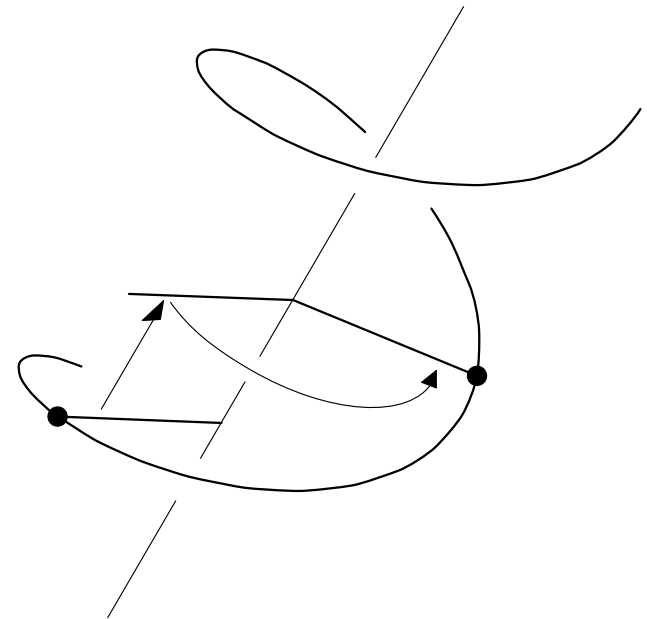

Analogous to centrodes . . .

On the sphere . . .

Plotting the instantaneous rotation axis in the fixed and moving frames gives *fixed and moving cones*.

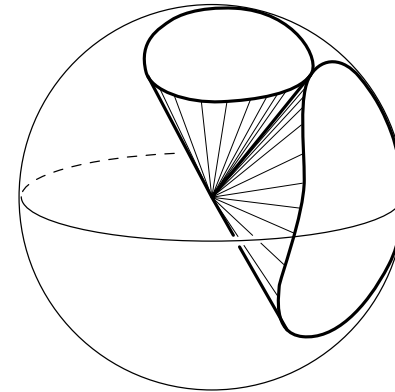

In three space . . .

Plotting the instantaneous screw axis in the fixed and moving frames gives *fixed and moving axodes*.

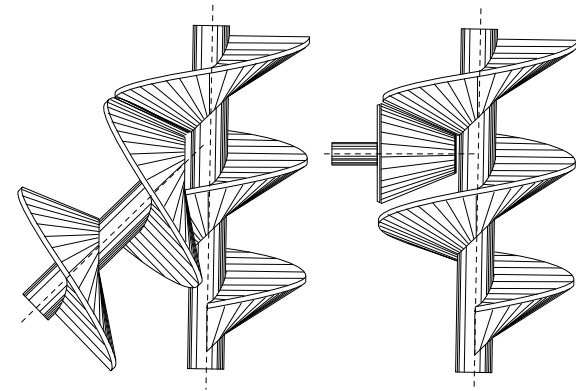

Kinematic constraint

One of the best manipulation tricks!

In simple cases, freedoms and constraints are just a matter of counting unknowns and equations.

$$\begin{aligned} & \text{nominal DOFs} \\ & - \text{independent constraints} \\ & = \text{DOFs} \end{aligned}$$

Things to worry about:

If an equation reduces DOFs by 1, does an inequation reduce DOFs by 1/2?

Identifying dependencies and singular cases.

Constraints on velocity versus on configuration.

Constraint in general

Consider constraints of the form

$$f(q, \dot{q}, t) = 0$$

or

$$f(q, \dot{q}, t) \geq 0$$

where

$q \in Q$ configuration space, e.g. (x, y, θ)

$\dot{q} \in TQ$ tangent space, e.g. $(\dot{x}, \dot{y}, \dot{\theta})$

$t =$ time

Constraint: taxonomy and examples

bilateral

Expressed as an equation. Two sided.

$$y = 0$$

$$\theta = 0$$

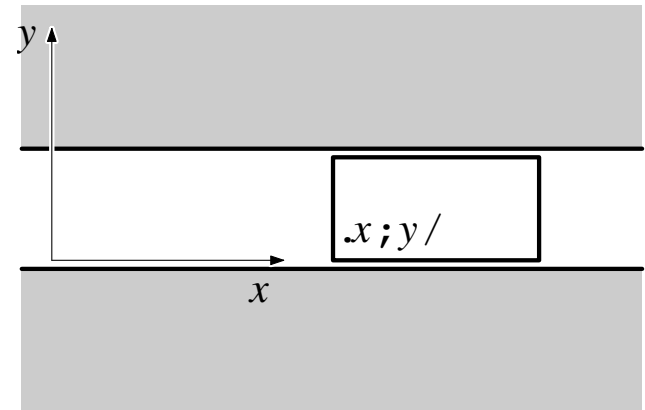

unilateral

Expressed as an inequation. One sided.

$$y \geq 0$$

$$y + 2 \sin \theta \geq 0$$

$$y + 2 \sin \theta + \cos \theta \geq 0$$

$$y + \cos \theta \geq 0$$

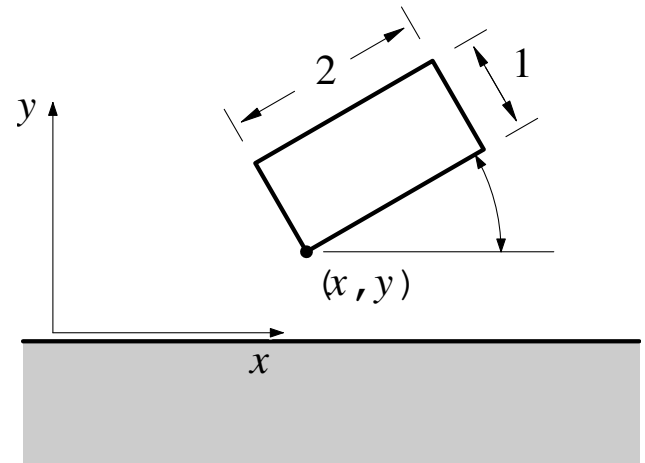

Constraint: taxonomy and examples

scleronomic

Independent of t . Stationary.

rheonomic

Depends on t .

$$x \sin(2\pi t) - y \cos(2\pi t) = 0$$

$$\theta = 2\pi t$$

holonomic

Independent of \dot{q} and bilateral.

$$f(q, t) = 0$$

nonholonomic

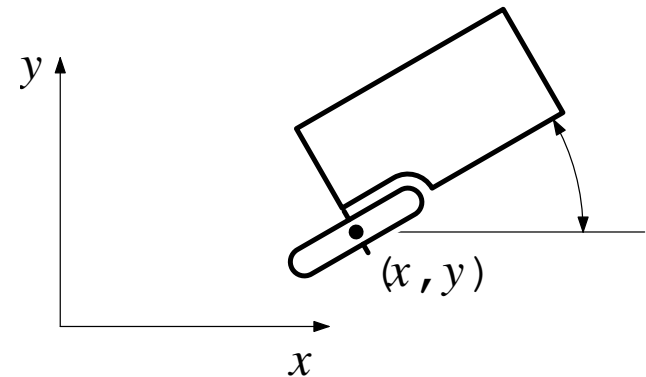
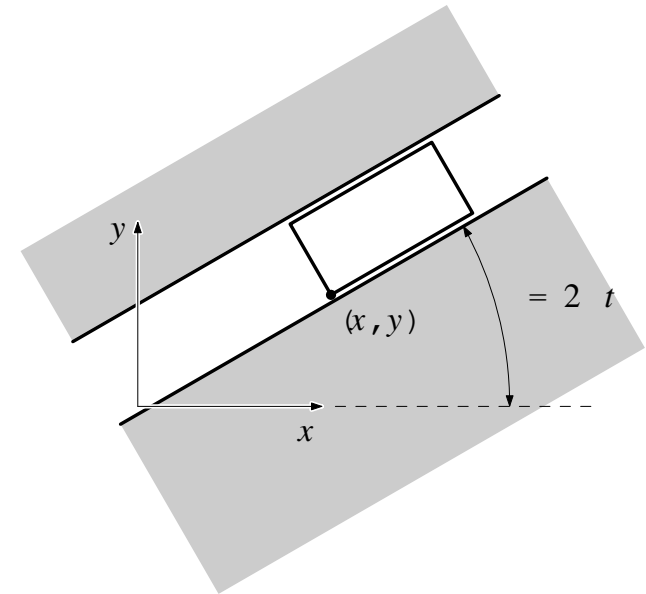

Analysis of planar constraints using velocity cent

Bilateral: recall technique from previous lecture. Construct perpendicular to allowed velocity at point. IC must be at intersection of perpendiculars.

Extension to unilateral. Perpendicular to constraint divides plane into positive IC's, negative IC's, and IC's of either sign.

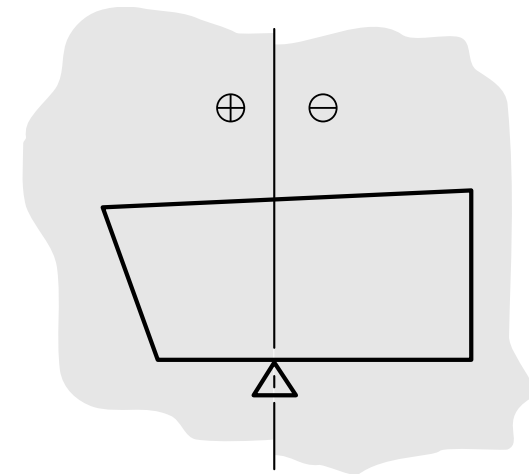
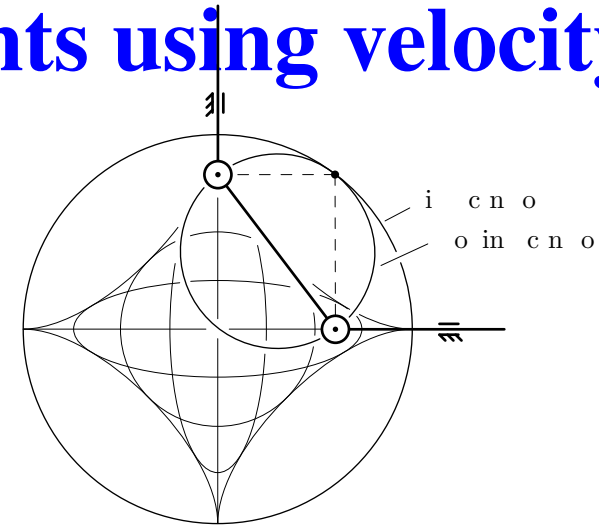

Multiple unilateral constraints (Reuleaux's method)

Can this triangle move?

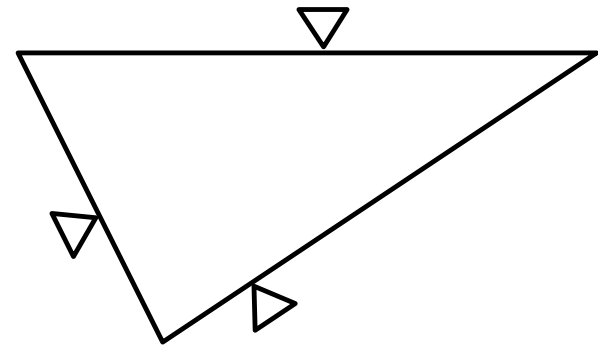

Multiple unilateral constraints (Reuleaux's method)

Can this triangle move?

Construct positive and negative half-planes for each contact.

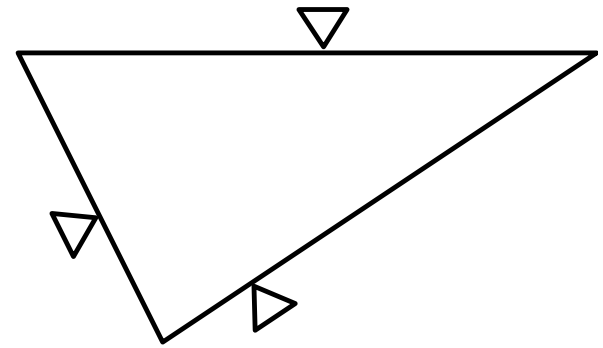

Multiple unilateral constraints (Reuleaux's method)

Can this triangle move?

Construct positive and negative half-planes for each contact.

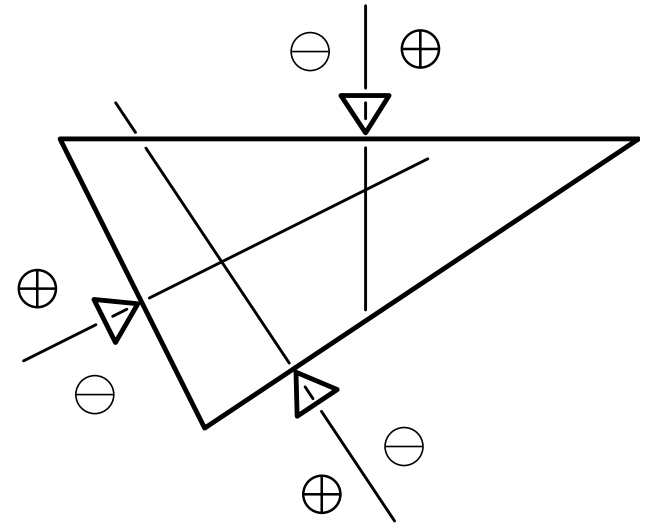

Multiple unilateral constraints (Reuleaux's method)

Can this triangle move?

Construct positive and negative half-planes for each contact.

Keep consistently labelled points.

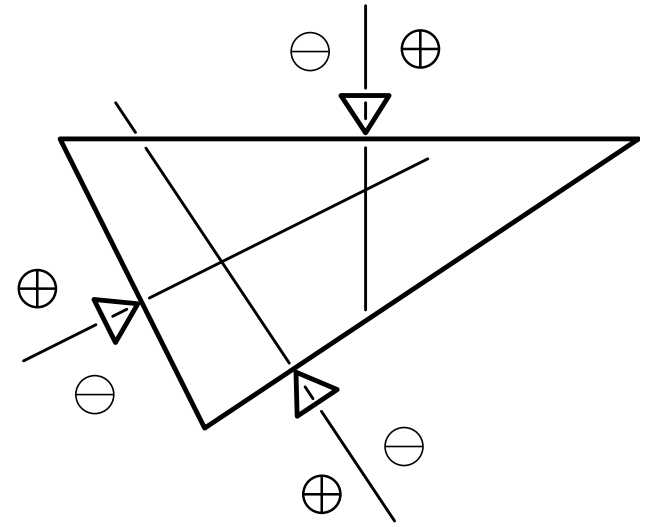

Multiple unilateral constraints (Reuleaux's method)

Can this triangle move?

Construct positive and negative half-planes for each contact.

Keep consistently labelled points.

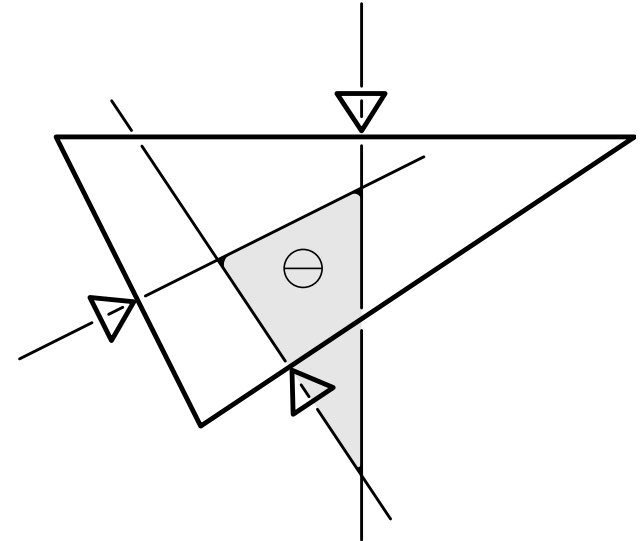

Multiple unilateral constraints (Reuleaux's method)

Can this triangle move?

Construct positive and negative half-planes for each contact.

Keep consistently labelled points.

Triangle can rotate CW about any
– point.

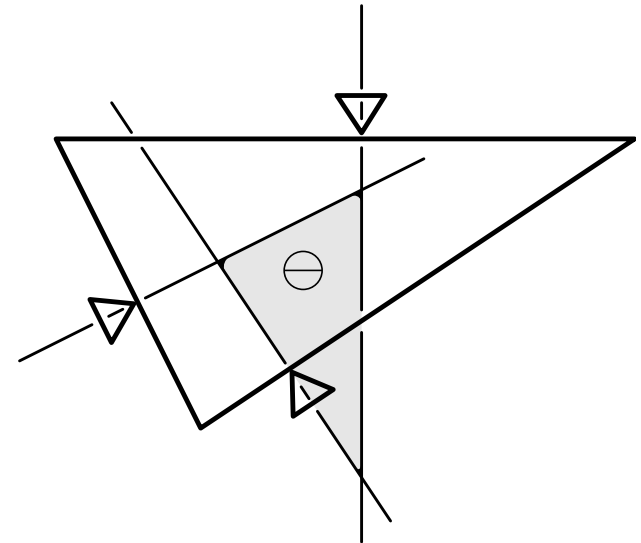

But watch for false positives

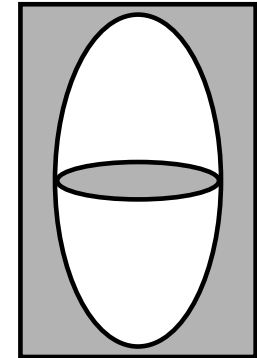
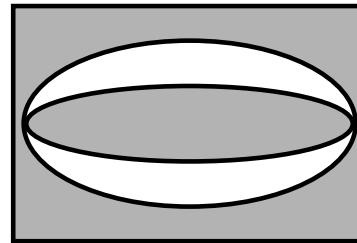
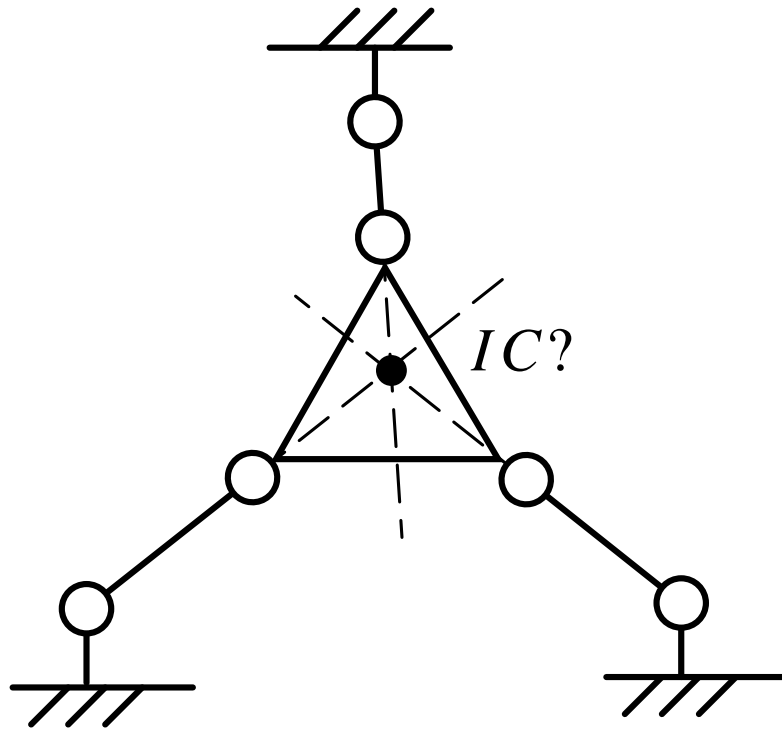

Chapter 1 Manipulation 1

- 1.1 Case 1: Manipulation by a human 1
- 1.2 Case 2: An automated assembly system 3
- 1.3 Issues in manipulation 5
- 1.4 A taxonomy of manipulation techniques 7
- 1.5 Bibliographic notes 8
- Exercises 8

Chapter 2 Kinematics 11

- 2.1 Preliminaries 11
- 2.2 Planar kinematics 15
- 2.3 Spherical kinematics 20
- 2.4 Spatial kinematics 22
- 2.5 Kinematic constraint 25
- 2.6 Kinematic mechanisms 34
- 2.7 Bibliographic notes 36
- Exercises 37

Chapter 3 Kinematic Representation 41

- 3.1 Representation of spatial rotations 41
- 3.2 Representation of spatial displacements 58
- 3.3 Kinematic constraints 68
- 3.4 Bibliographic notes 72
- Exercises 72

Chapter 4 Kinematic Manipulation 77

- 4.1 Path planning 77
- 4.2 Path planning for nonholonomic systems 84
- 4.3 Kinematic models of contact 86
- 4.4 Bibliographic notes 88
- Exercises 88

Chapter 5 Rigid Body Statics 93

- 5.1 Forces acting on rigid bodies 93
- 5.2 Polyhedral convex cones 99
- 5.3 Contact wrenches and wrench cones 102
- 5.4 Cones in velocity twist space 104
- 5.5 The oriented plane 105
- 5.6 Instantaneous centers and Reuleaux's method 109
- 5.7 Line of force; moment labeling 110
- 5.8 Force dual 112
- 5.9 Summary 117
- 5.10 Bibliographic notes 117
- Exercises 118

Chapter 6 Friction 121

- 6.1 Coulomb's Law 121
- 6.2 Single degree-of-freedom problems 123
- 6.3 Planar single contact problems 126
- 6.4 Graphical representation of friction cones 127
- 6.5 Static equilibrium problems 128
- 6.6 Planar sliding 130
- 6.7 Bibliographic notes 139
- Exercises 139

Chapter 7 Quasistatic Manipulation 143

- 7.1 Grasping and fixturing 143
- 7.2 Pushing 147
- 7.3 Stable pushing 153
- 7.4 Parts orienting 162
- 7.5 Assembly 168
- 7.6 Bibliographic notes 173
- Exercises 175

Chapter 8 Dynamics 181

- 8.1 Newton's laws 181
- 8.2 A particle in three dimensions 181
- 8.3 Moment of force; moment of momentum 183
- 8.4 Dynamics of a system of particles 184
- 8.5 Rigid body dynamics 186
- 8.6 The angular inertia matrix 189
- 8.7 Motion of a freely rotating body 195
- 8.8 Planar single contact problems 197
- 8.9 Graphical methods for the plane 203
- 8.10 Planar multiple-contact problems 205
- 8.11 Bibliographic notes 207
- Exercises 208

Chapter 9 Impact 211

- 9.1 A particle 211
- 9.2 Rigid body impact 217
- 9.3 Bibliographic notes 223
- Exercises 223

Chapter 10 Dynamic Manipulation 225

- 10.1 Quasidynamic manipulation 225
- 10.2 Brie y dynamic manipulation 229
- 10.3 Continuously dynamic manipulation 230
- 10.4 Bibliographic notes 232
- Exercises 235

Appendix A Infinity 237